

ORECK

Steam 50

User's Guide

clean home[®]
HEALTHIER. EASIER. SMARTER.[®]

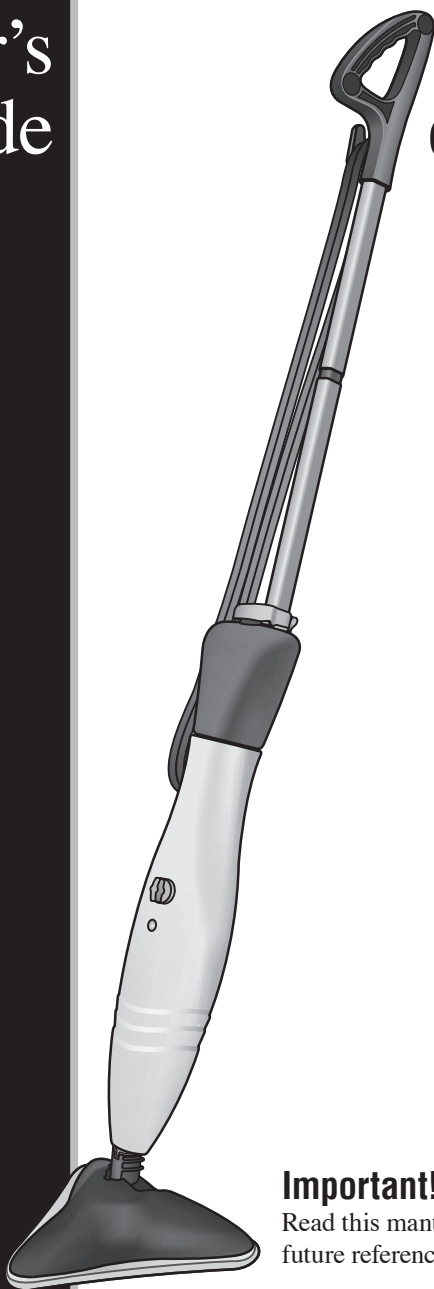

Important!

Read this manual carefully, and keep for future reference.

Enjoy

Thank You for purchasing one of our top-of-the-line Oreck® Steam 50 Steam Cleaners. This powerful, environmentally friendly cleaner will help you clean both hard floors and refresh carpets*.

**ORECK**

At Oreck, we understand that our customers are unique and expect superior service. To meet your needs, we offer different customer service options to accommodate your lifestyle and preference.

Welcome to our **Call. Click. Visit.** customer service program. To speak with an Oreck representative call, click or visit using the information below.

Call



USA: **1•800•989•3535**
Canada: **1•888•676•7325**

Click



On the web, point and click at: **www.oreck.com**
or visit www.oreck.com and click locate a store on the top right.

Visit



Visit us in person at one of over 450 store locations. To find the nearest store, please call **888•oreck (1•888•673•2578)**.

*The Steam 50 is practical for any surface **with the exception of those surfaces that are extremely heat sensitive**. We recommend **NOT** using it on fine silks, delicate materials such as velour, some very thin plastics, unsealed hardwood, ceilings, drywall, and exterior paint of automobiles, electronics or items using electricity. If ever in doubt, test a small area before beginning extensive cleaning.

Contents

Safety	4
General Warnings	4
Parts and Features	7
Product Components & Accessories	7
Assembly	8
Use	9
Steam Cleaning Hard Floors	9
Before You Begin Cleaning	9
Cleaning	10
After Cleaning	11
Steam 50 Care and Cleaning	12
Troubleshooting	13
Parts	14
Warranty	15

IMPORTANT SAFETY INSTRUCTIONS

Read all instructions before using this steam cleaner

WARNING! To reduce the risk of fire, electric shock, or injury when using an electrical appliance, basic precautions should always be followed, including the following:

- Do not leave appliance unattended when plugged in. Unplug from outlet when not in use and before servicing.
- To prevent shock, do not use outdoors. The steam cleaner is intended for household use only.
- Do not let the unit run while in any one stationary position for any period of time. Keep the unit moving while in operation.
- Do not allow to be used as a toy. Close attention is necessary when used near children.
- Use only as described in this manual. Use only manufacturer's recommended attachments.
- Do not use with damaged cord or plug. If appliance is not working as it should, has been dropped, damaged, left outdoors, or dropped into water, return it to a service center or call customer service at: US: 1-800-989-3535
Canada: 1-888-676-7325.
- Do not pull or carry by the power cord, use cord as a handle, close a door on the power cord, or pull the power cord around sharp edges or corners.
- Keep the power cord away from heated surfaces.
- Do not run the steam cleaner over the power cord.
- Do not unplug by pulling on the power cord. To unplug, grasp the plug, not the power cord.
- Do not use an extension cord.
- Do not handle plug or appliance with wet hands.
- Turn off all controls before unplugging. Always remove the power cord from the outlet and handle the steam cleaner with care when filling the water tank with water.
- Do not over fill the water tank. Do not exceed the maximum fill level. Use the measuring jug to measure the correct amount of water.

- Do not use without the water tank cap in place. Check that the water tank cap is completely screwed down before use.
- Do not operate without water in the water tank.
- Do not fill the water tank with anything other than water or Oreck Fresh Air® Steam Mop Essence. Never put additives (such as perfume, stain remover, or products containing alcohol) in the water as they may damage the steam cleaner or make it dangerous to use.
- Empty the water tank when the steam cleaner is not in use.
- Do not touch any hot areas on the steam cleaner. It is normal for the steam cleaner to heat up during operation.
- The force and heat of the steam may have an adverse effect on some materials. Always test the steamer on a small concealed area to determine if it is suitable for treatment.
- Accessories become hot during use. Allow them to cool down before handling them.
- Never point or aim the steam cleaner at people, animals or plants (risk of scalding!). Do not aim the steam cleaner at electrical systems or wires.
- Connecting the steam cleaner to improper voltage may result in damage to the steam cleaner and possible injury. Always plug the steam cleaner into a power outlet with the correct voltage. See the rating label on the unit for the correct voltage.

Grounded Plug

This appliance must be grounded. If it should malfunction or break down, grounding provides a safe path of least resistance for electrical current, reducing the risk of electrical shock. The cord for this appliance has an equipment-grounding conductor and a grounding plug. It must only be plugged into an electrical outlet that is properly installed and grounded in accordance with all local codes and ordinances.

DANGER: Improper connection of the equipment-grounding conductor can result in a risk of electrical shock. Check with a qualified electrician or service person if you are in doubt as to whether the outlet is grounded. If not, have a proper outlet installed by a qualified electrician.

This appliance is for use on nominal 120-volt circuit. It has a grounding plug similar to the example shown. Make sure the appliance is connected to an outlet with the same configuration as the plug. No adapter should be used with this appliance.

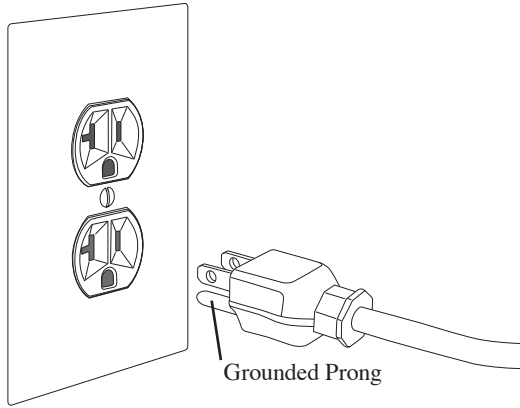

SAVE THESE INSTRUCTIONS
For household use only

Parts and Features

Product Components & Accessories

The Steam 50 makes cleaning tile, vinyl, and sealed hard floors easy. It is lightweight, portable, and easy to store. The Steam 50 is ready to clean in thirty seconds and will automatically turn off when it is in the upright position. The parts and features include:

Front View

1. Handle tube
2. Lower tube
3. Power cord
4. Tank clamp
5. Water tank: The Transparent Water Tank lets you see the level of water remaining, letting you know when to refill.
6. Steam 50 Body
7. Steam switch knob: The Steam Control lets you choose between a light or heavy-duty steam level.
8. Swivel floor head: The 360° Swivel Floor Head with three corners provides flexibility, ease of movement, and unlimited reach when using the steam cleaner.

Accessories

9. Cleaning pad
10. Carpet Glider

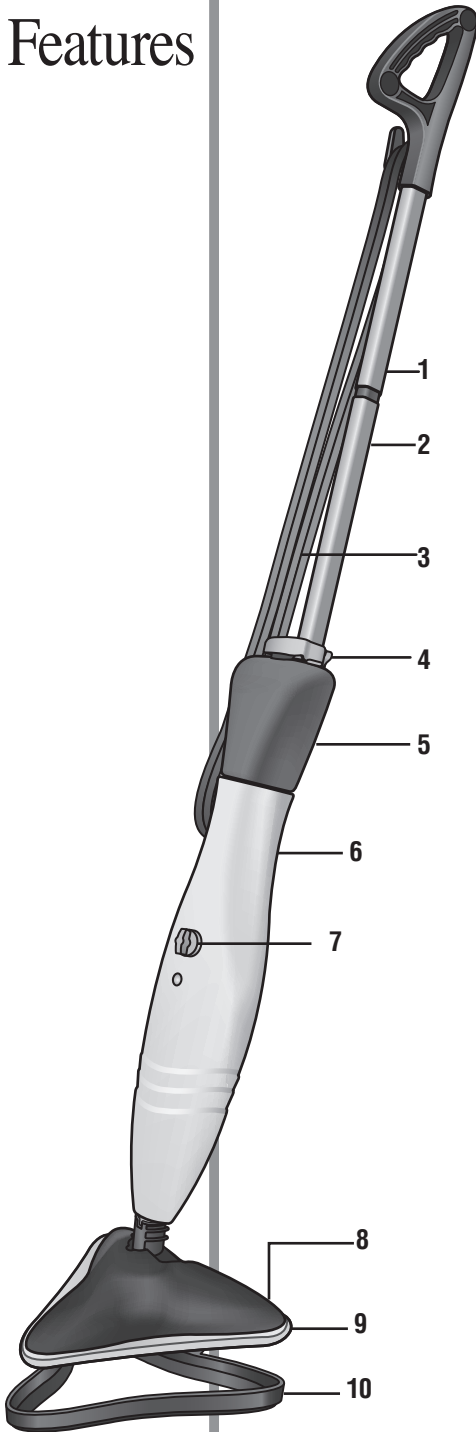

Assembly

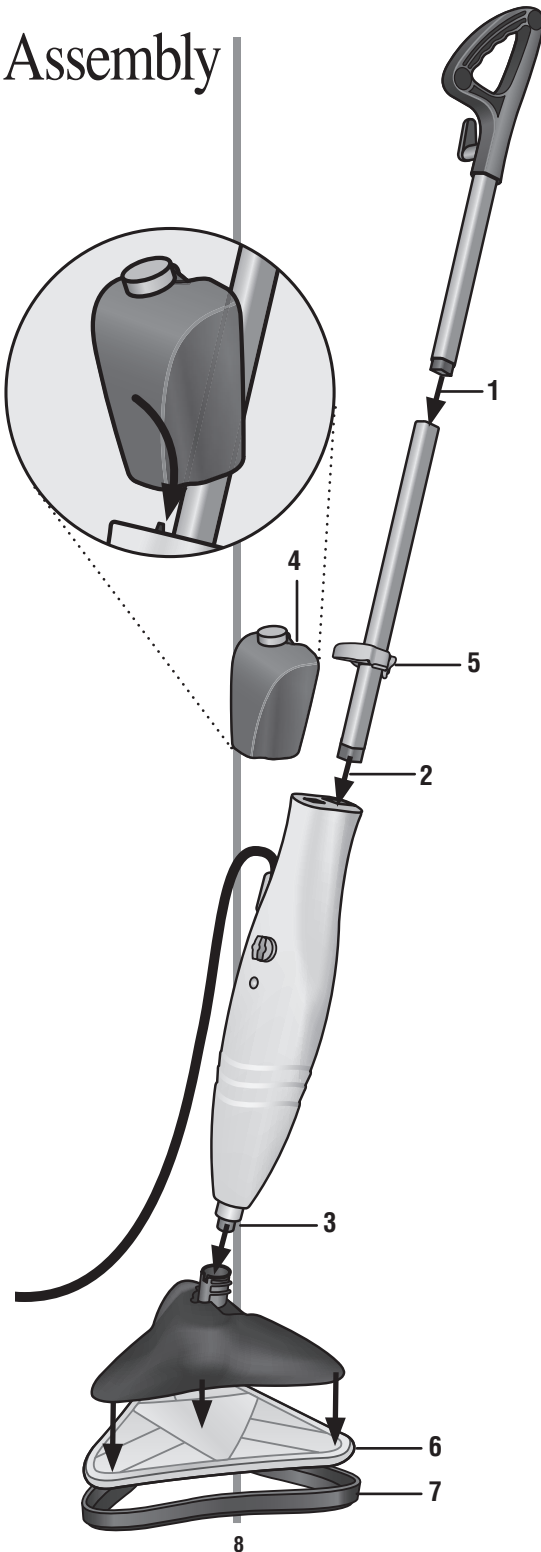

⚠ WARNING!



Do not plug the steam cleaner into an electrical outlet during assembly.

1. Insert the Lower Tube into the Handle Tube. Be sure the two handles are securely attached by pulling on the upper and lower tubes.
2. Insert the tube assembly into the Body until it clicks into place.
3. Insert the nozzle on the bottom of the Body into the Floor Head until the nozzle is seated in the hole of the Floor Head.
4. Place the Water Tank on the tube assembly. Slide it down until properly seated into the Body.
5. Slide the tank clamp down over the top of the Water Tank and close the lock.
6. Align the Velcro® strips on the pad and floor head. Press the two together to secure the pad to the floor head.
7. When refreshing carpet, place the Carpet Glider on the Cleaning Pad and Floor Head.

NOTICE

• The Steam 50 DOES NOT have an ON/OFF switch. When the unit is plugged in it is ON. Steam will only be produced when unit is tilted back from the upright position. Always unplug the unit when not in use!

• Always use the cleaning pad when cleaning hard floors. Ensure cleaning pad is in place and properly attached to the floor head.

⚠ WARNING!

Do not plug the steam cleaner into an electrical outlet during assembly.



To reduce the risk of personal injury, unplug cord from electrical outlet and let the unit/accessories cool down completely before handling.

NOTICE

- Always turn the steam switch knob to the closed position before installing a filled water tank.
- Do not leave the steam cleaner in one spot on any surface for an extended period of time with a damp or wet cleaning pad attached. This may damage the floor surface.
- The steam cleaner should only be used on tiles, linoleum, or sealed wood flooring. Do not use on laminate flooring*.
- Always use the cleaning pad when cleaning hard floors. Ensure cleaning pad is in place and properly attached to the floor head.
- The force and heat of the steam may have an adverse effect on some materials. Always test the steamer on a small concealed area to determine if it is suitable for treatment.

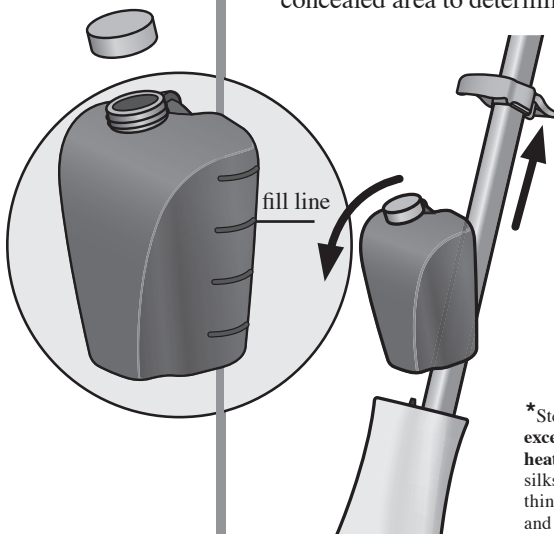
**Before You Begin Cleaning**

1. Unlock the clamp and slide it up the tube assembly.
2. Remove the water tank.
3. Remove the cap on the water tank.
4. Fill the water tank 3/4 full. Do not overfill the water tank.

*Steam 50 is practical for any surface **with the exception of those surfaces that are extremely heat sensitive**. We recommend **NOT** using it on fine silks, delicate materials such as velour, some very thin plastics, unsealed hardwood, ceilings, drywall, and exterior paint of automobiles, electronics or items using electricity. If ever in doubt, test a small area before beginning extensive cleaning.

4. Put the cap on the water tank and close completely. Place the tank back into the body. Check that the water tank is properly seated.
5. Slide the clamp over the top of the water tank and close the lock.
6. Vacuum or sweep the floor completely before using the steam cleaner.
7. Plug the power cord into a polarized electrical outlet. Wait approximately thirty seconds for the steam indicator to light up.
8. Adjust the Steam Switch Knob to the desired level of steam.

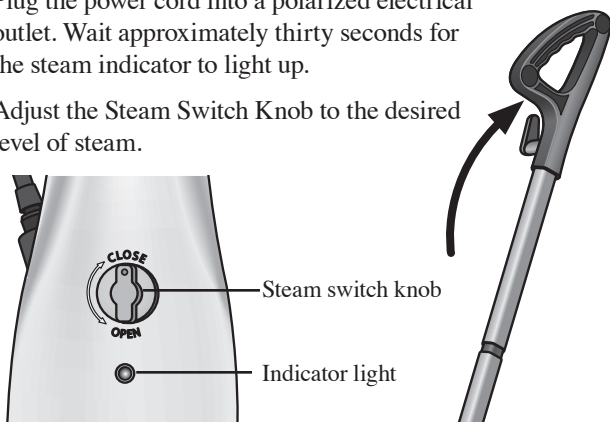
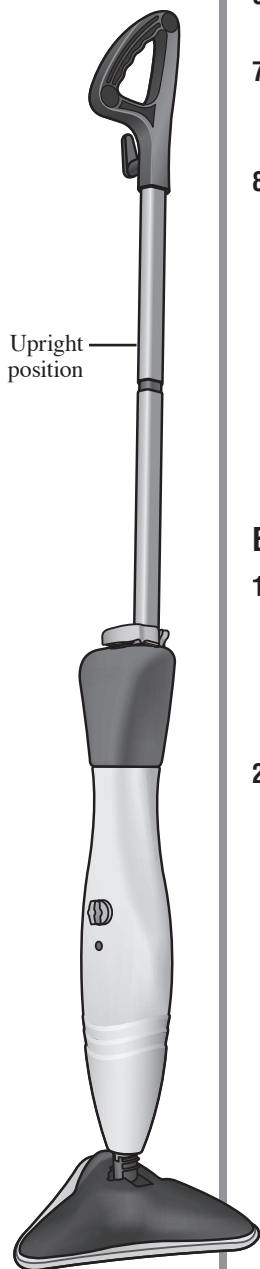

Begin Cleaning

1. Pull back on the handle to release the steamer.

Important! Steam will stop automatically when the unit is in the upright position.

2. Move the steam cleaner slowly back and forth across the floor.

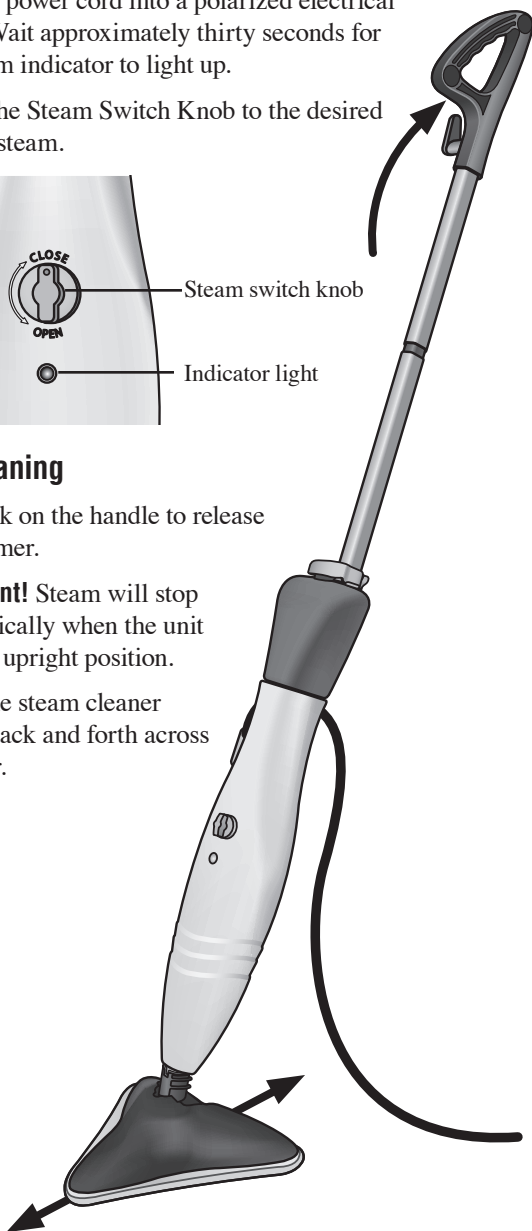

After Cleaning

⚠ WARNING!



To reduce the risk of personal injury, unplug cord from electrical outlet and let the unit/accessories cool down completely before handling.



1. Unplug the steamer.
2. Move the Steam Switch Knob to the closed position.



3. Unlock the clamp and slide it up the tube assembly.
4. Remove the water tank.
5. Over a sink, turn the cap counter-clockwise and remove the cap on the water tank. Empty the water. Put the cap back on the water tank and close completely.
6. Place the water tank back onto the body. Check that the water tank is properly seated.
7. Slide the clamp over the top of the water tank and close the lock.
8. Remove the pad after it has cooled.

Steamer 50 Care and Cleaning

NOTICE

Never use bleach or fabric softener when washing the cleaning pad.

Cleaning the Pad

1. Using mild detergent, machine wash at maximum 104° F (40° C).
2. Allow the pad 24 hours to dry.

Steamer Care

- Wipe the surfaces of the cleaner with a soft cloth
- Store upright in a dry, protected area

Trouble-shooting

Service problems that appear to be major can often be solved easily. You can be your own troubleshooter by reviewing this guide. All other servicing should be done by an Oreck authorized service center.

Problem	Check	Solution
Cleaner will not run	<ul style="list-style-type: none"> • The power cable is damaged or plug in properly. • Wall outlet is faulty. 	<ul style="list-style-type: none"> • Be sure cleaner is firmly plugged into wall outlet. • Check electrical source – fuse or circuit breaker.
Steam is not emitted when the steam cleaner is ON.	<ul style="list-style-type: none"> • Water tank is empty. • Hard water filter is clogged. • The steam switch knob is not in the open position. 	<ul style="list-style-type: none"> • Fill water tank. • Change water filter. • Wash or replace the cleaning pad. • Contact Oreck for service.
Peculiar smell is coming from the unit.		<ul style="list-style-type: none"> • If this is the first time using the cleaner, continue use. The smell is normal when parts are heated for the first time. • Discontinue use if the problem persists and contact Oreck for service.
Unit still does not operate properly.	Check all the above points.	Contact Oreck for service.

Parts

To order, call our customer service group or visit our website. Please have your model number from the data label on the bottom of the unit.

Item	Number
Replacement Parts	
Cleaning Pad, 4 pack	STEAMKIT50

Warranty

Steam 50 Steam Cleaner

ORECK MANUFACTURING COMPANY: (Oreck Manufacturing Company gives you the following limited warranty for this product only if it was originally purchased for residential use, not resale, from Oreck or an Oreck Authorized Retail Dealer.)

Oreck will repair or replace, free of charge, to the original purchaser, any part that is found to be defective in material or workmanship within six (6) months of the date of purchase. This limited warranty applies to normal domestic use. Any commercial use of this product will void this limited warranty.

This limited warranty does not cover the replacement of expendable or consumable parts such as cleaning pads and other parts subject to normal wear unless they are defective in material or workmanship.

This limited warranty does not apply to any part subjected to accident, abuse, commercial use, alteration, misuse, damage caused by act of God, the use of voltages other than indicated on the serial number displayed on this product or service of this product by other than Oreck or a participating Factory Authorized Service Center. Oreck does not authorize any person or representative to assume or grant any other warranty obligation with the sale of this product.

Oreck's limited warranty is valid only if you retain proof of purchase from Oreck or an Oreck Authorized Retail Dealer for this product. If you purchase this product from any other source, your purchase is "AS IS," which means Oreck grants you no warranty, and that you, not Oreck, assume the entire risk of the quality and performance of this product, including the entire cost of any necessary servicing or repairs of any defects.

Oreck's liability for damages to you for any costs whatsoever arising out of this statement of limited warranty shall be limited to the amount paid for this product at the time of original purchase, and Oreck shall not be liable for any direct, indirect, consequential or incidental damages arising out of the use or inability to use this product. Some states do not allow the exclusion or limitation of incidental or consequential damages, so the above limitation or exclusion may not apply to you.

ALL EXPRESS AND IMPLIED WARRANTIES FOR THIS PRODUCT, INCLUDING IMPLIED WARRANTIES OF MERCHANTABILITY AND FITNESS FOR A PARTICULAR PURPOSE, ARE LIMITED IN DURATION TO THE WARRANTY PERIOD, AND NO WARRANTIES, WHETHER EXPRESS OR IMPLIED, WILL APPLY AFTER THIS PERIOD.

Some states do not allow limitations on the duration of implied warranties, so the above limitation may not apply to you.

This warranty gives you specific legal rights, and you may also have other rights which vary from state to state. If appropriate, see additional information for extended warranty.



ORECK®

ORECK®

© 2010 Oreck Holdings, LLC.

All rights reserved. All marks, text, logo's, product configurations and registered trademarks are owned and used under the authority of Oreck Holdings, LLC

53544-01 REV A 08/10 ECN R-10092